

# Parking Guidance System

---

## Installation Manual

---

# 1. System Overview

Been widely applied in large car parks at commercial buildings, hotel, railway station, airport, shopping mall etc., PGS monitors the real time parking space availability and guides drivers to unoccupied slots, greatly shorten their time spent looking for parking. The system helps improve parking space usage rate, lower operation costs and improve public image of the facility management; it also helps to create an eco friendly facility by reducing air pollution.

Please refer to the picture below, by installing an ultrasonic sensor above each and every parking space, PGS monitors the availability of the space, Data Collector (NCU) collects the information of all sensors and transmit to Centre Processor (CCU), CCU processed the data and save the information to the Management Software database, at the meantime, availability information are shown on LED Display which will be installed at entrances, exits and intersections to tell drivers which direction to take.

## 2. System Composition & Wiring

PGS system is composed of the listed items and each of them is connected as in the Wiring Diagram below:

- 1) **Ultrasonic Sensor** (Refer to **Page 2~4** for more details)
- 2) **Data Collector** (Refer to **Page 5~6** for more details)
- 3) **Centre Processor** (Refer to **Page 6~8** for more details)
- 4) **LED Display** (Refer to **Page 8~9** for more details)
- 5) **Management Software** (Refer to **Page 9~10** for more details)

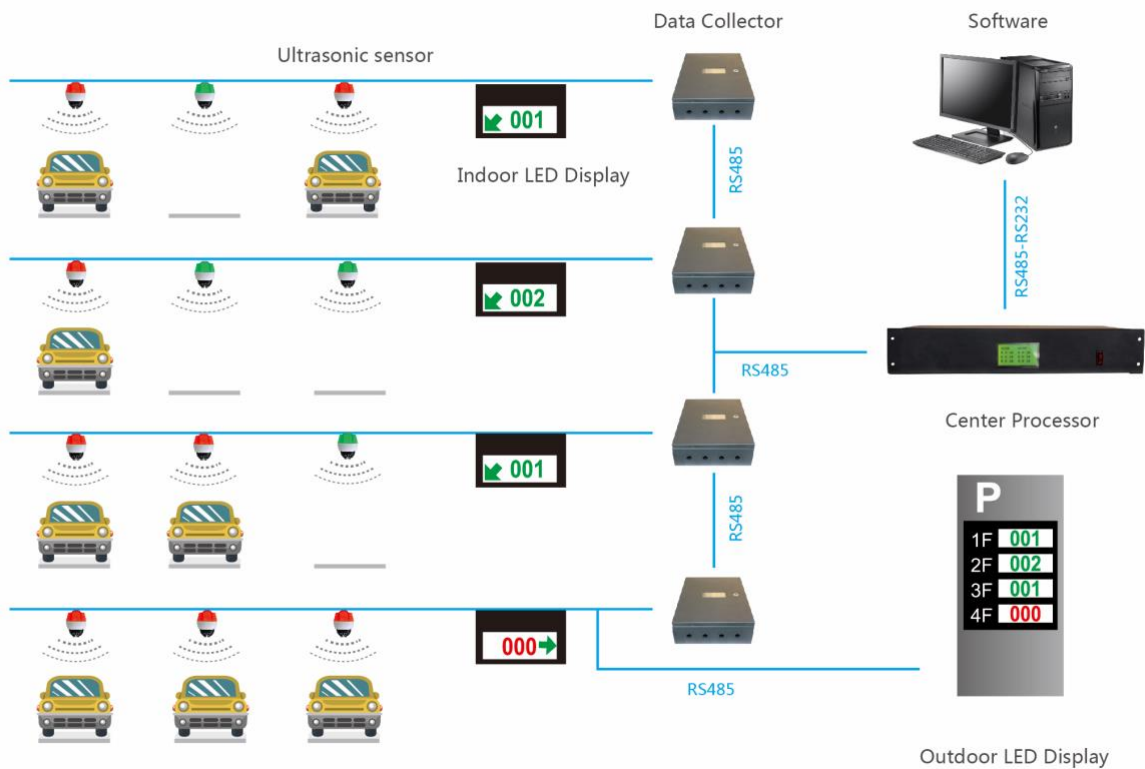

Picture 1–Wiring Diagram

## 3. Ultrasonic Sensor

### 3.1 Overview

As a basic but vitally important component of the Parking Guidance System, Ultrasonic Sensor adopts ultrasonic detection technology (with a sender and a receiver) to monitor presence of vehicles over parking slots and provides real-time, dynamic availability information of parking spaces.

**P.S. To be installed to the front middle of all parking spaces!**

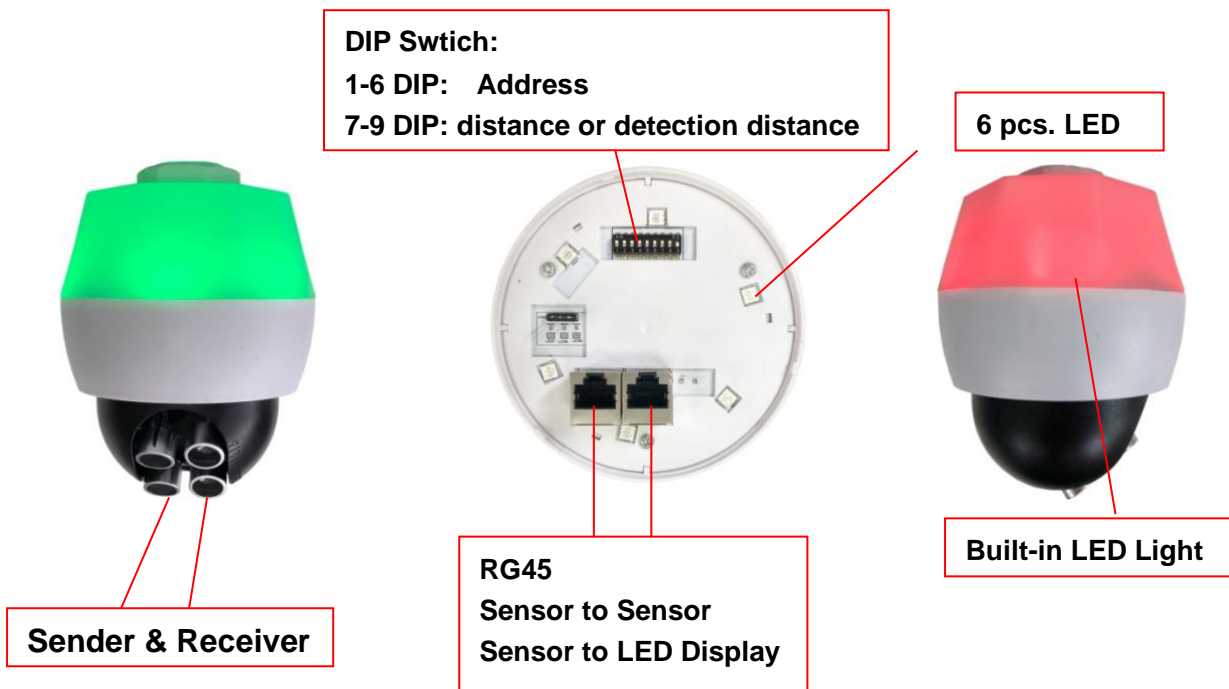

Picture 2–Ultrasonic Sensor

### 3.2 Working Principle

Sender sends ultrasound which travels at 340m/s, when the sound wave reaches an object, it will be reflected and received by Receiver. Sensor calculates the distance of the reachable object by  $Sound\ Speed * Travel\ Time / 2$  and judges if there is a car.

### 3.3 Detection Mode

**3.3.1 Ground detection:** sensor detects the ground (when there's no car, ultrasound reaches the ground, reflected and received; when a car is parked, distance will be shorten and sensor recognize presence of the car)

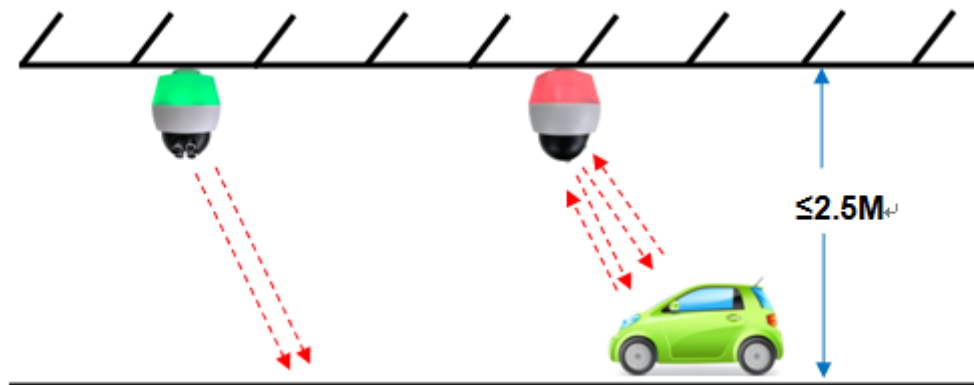

### Picture 3–Ground Detection

**3.3.2 Car Detection:** sensor detects the car (detecting distance was set and ultrasound can not reach the ground, when there's no car, there's no reflection; when a car is parked, the wave will be reflected and received)

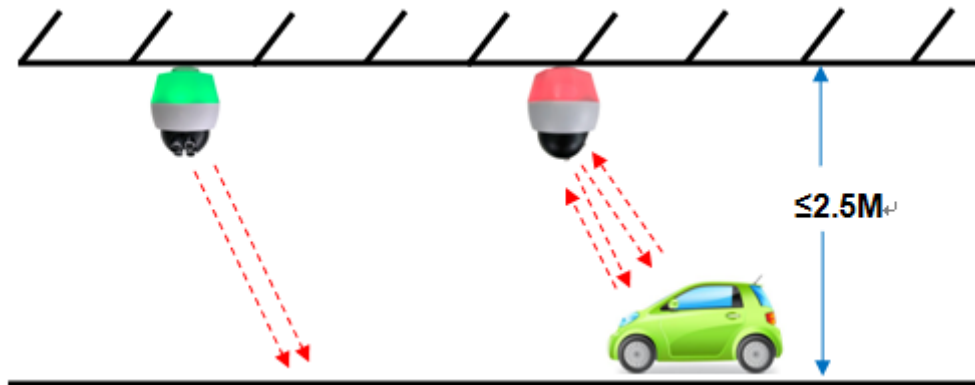

Picture 4 –Car Detection

### 3.4 Specifications

Dimension	10.5cm(D)*14cm(H)	Weight	0.2kg
Color	Bottom: Frosted White Top: Black	Housing	ABS
Working Voltage	DC24V	Peak Current	35mA
Frequency	40KHz	Sensitivity	>-25dB
Communication Mode	RS485	Transmission Distance	<1000m
Detection Angle	30°~55° Adjustable	Detection Distance	1.8-3.5m
Working Temperature	-25~70°C	Error	±0.2m

# 4 Data Collector

## 4.1 Overview

Data Collector manages sensors and LED display by group, it checks sensor information repeatedly and transmits data to Centre Processor for final processing; and also serves as the bridge to transfer availability information from Centre Processor to LED Displays.

P.S. A Data Collector manages up to 60 sensors and 20 LED displays!



Picture 5–Data Collector Inner View

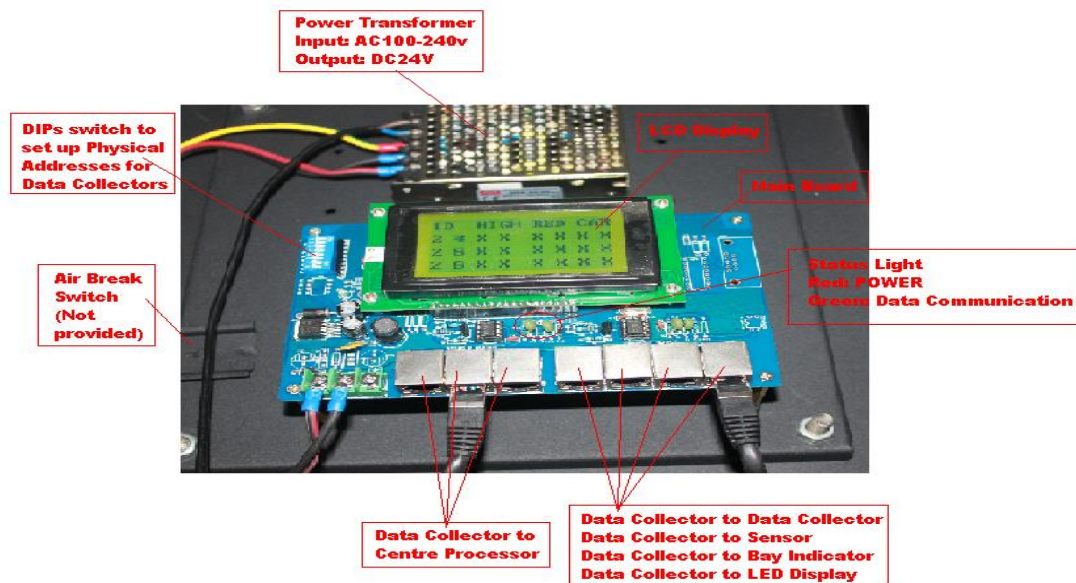

Picture 6– Data Collector

**ID:** Physical address

**HIGH:** Detection distance (Meter)

**RED:** Detection mode

**CAR:** Occupancy status

**XX:** No data (Hint: sensor faulty, not connected or improperly configured)

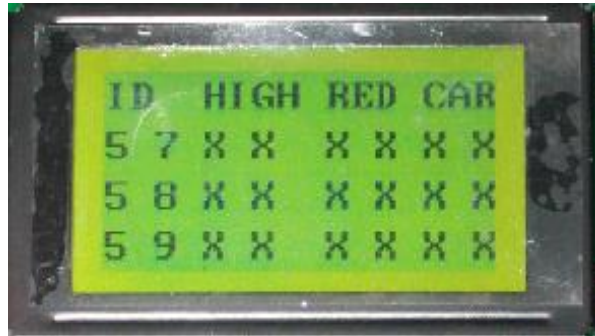

**Picture 7– Data Collector LCD**

## 4.2 Specifications

Dimension	43cm*34cm*12cm	Weight	8.75kg
Color	Frosted Black	Housing	Iron
Working Voltage	DC24V	Peak Current	45mA
Communication Mode	RS485	Frequency	4800Mps
Transmission Distance	1000m	Working Temperature	-25~70°C

# 5 Centre Processor

## 5.1 Overview

Centre Processor is core of PGS system. It deals with the analysis of data, feedback the information to Management Software database and release information to be shown on LED displays to realize the guidance function.

**P.S. A Centre Processor manages up to 60 Data Collectors!**



Picture 8–Centre Processor

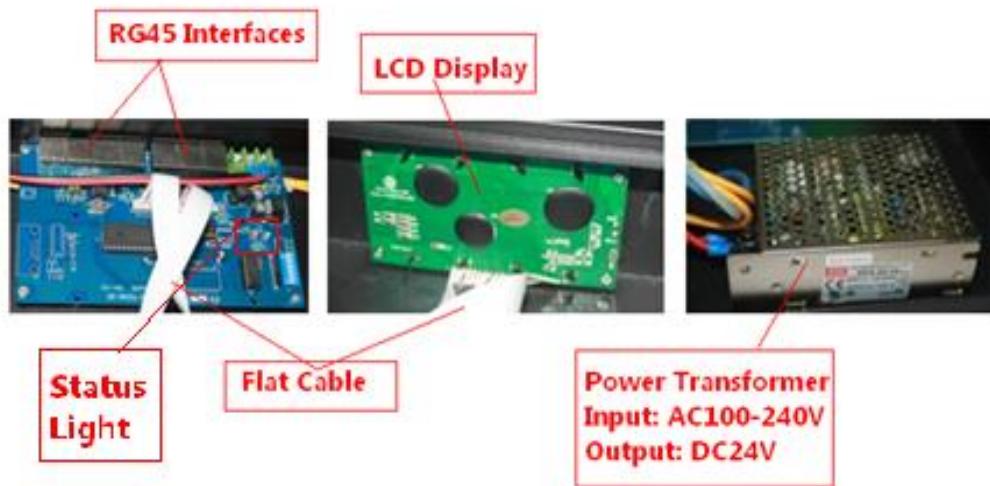

Picture 9–Centre Processor Inner View

ADDR: Data Collector Address  
 OK: Data Collector perform well  
 XX: Communication problem of Data Collector



Picture 10–Centre Processor LCD



## 5.2 Specifications

Dimension	48cm*20cm*8.6cm	Weight	3.7kg
Color	Black	Housing	Iron
Working Voltage	DC24V	Peak Current	35mA
Communication Mode	RS485	Frequency	4800Mps
Transmission Distance	1000m	Working Temperature	-25~70oC

## 6 LED Display

### 6.1 Overview

LED Display is installed at entrances, exits and intersections of the parking to tell drivers the space availability in each area, level and the entire garage, guide them which direction to take.

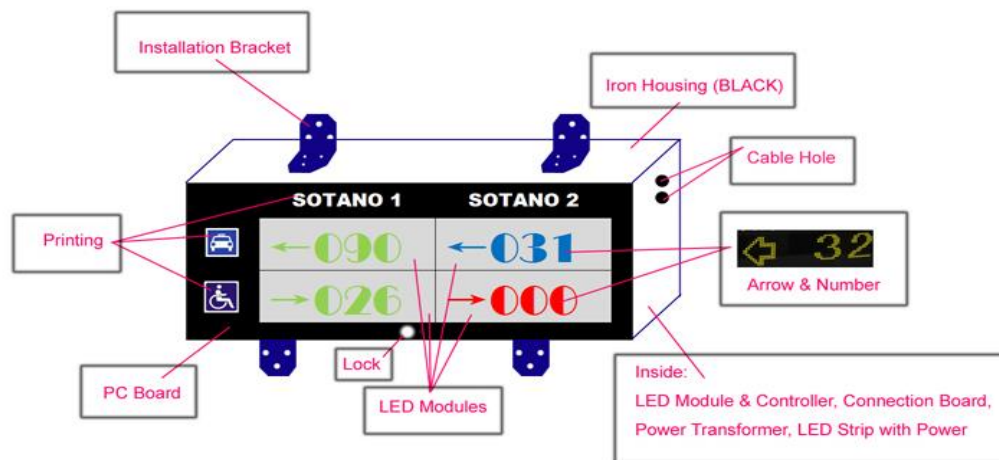

Picture 11-LED Display

In accordance with real need, the quantity of LED module differs, and Size of the iron housing for LED Display also differs accordingly, normally we use two sizes of module as in the picture below. For colors, normally Red/Green is used for Standard spaces and Red/Blue for Disabled.

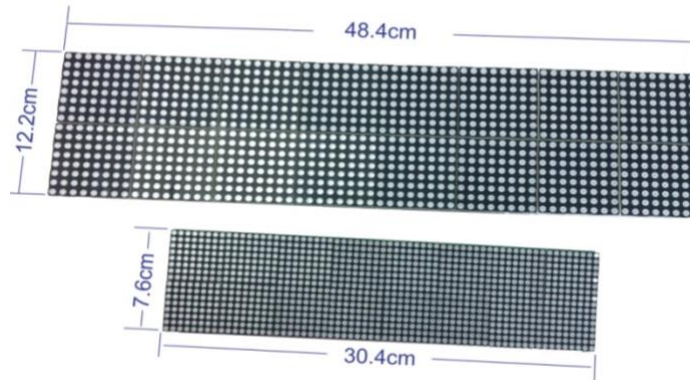

Picture 12–LED Modules

## 6.2 Specifications

Working Voltage	DC5V	Frequency	50-60Hz
Communication Mode	RS485	Transmission Distance	<1000m

# 7 Management Software

## 7.1 Overview

PGS Management Software is a graphical application developed based on Window 7 and SQL database software, with intuitive UI, simplified operation and complete statistics functions.



Picture 13–Management Software

## 7.2 Key Functions

- Real-time dynamic parking information display: occupancy status of parking spaces
- Statistical reports: parking time, parking usage, car flow and overtime parking statistics
- Multiuser with different authorities: definable user & roles
- Remote configuration: manage LED Display from PC
- Facility supervising: real-time supervising all PGS components, false will be set off in case of error





## 7.3 System Requirements

Brand	Dell or Lenovo recommended	Display	17 inch LED
Memory	1G or above	CD-ROM	Required
CPU	Intel Pentium 1.8G or above	USB Port	Recommended
HD	80G or above	OS	Window Seven
DATABASE	Microsoft SQL Server 2008 R2	Others	At least one RS232 Serial Port

# 8 Installation & Configuration

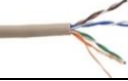
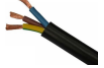
## 8.1 Hardware Installation

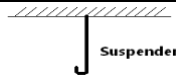
### a. Installation Materials Preparation

Cables	CAT5 (8*0.58mm) 3 meter/pcs with RJ45	For connection between Sensors and Indicators	
	CAT5 (8*0.58mm) without RJ45	For connection between Data Collectors	
	RVV single cord 1.5mm*3	For AC110V/220V power supply	
Tubes/Cable Tray & Accessory	PVC/KBG 20mm tube Accessories: Bold connection Elbow connection Straight joint	To carry CAT5 cable	
Suspender	12mm Diameter	To hang PVC/KBG tubes onto the ceiling	
Air Break Switch	Local Standard	For all AC110V/220V power supply	
COM Cable	RS232	For Centre Processor to PC connection	

---

**b. Cabling**

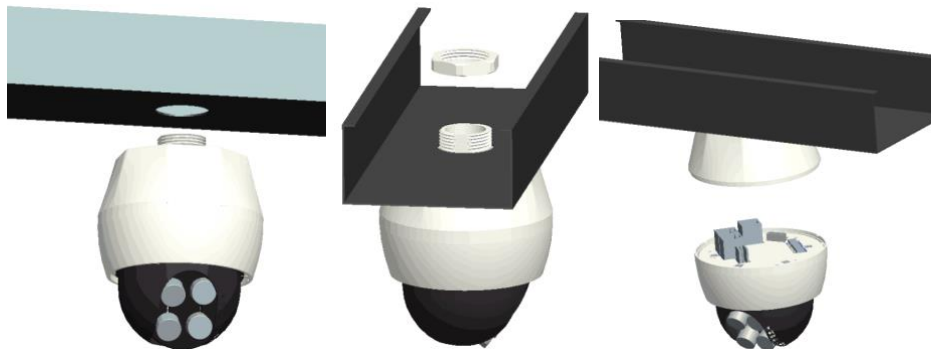

**Picture 14–Cabling**

Refer to above Picture 14, PVC tube, KBG tube or metal tray will be used to carry the cables; and the tubes/cable tray are hanged onto the ceiling with suspenders. During the cabling, back cover for sensor and indicators are fixed also.

**c. Install Ultrasonic Sensor**

After the cabling, simply plug the RJ45s to the sensors (properly configured) according to the wiring diagram in PAGE 4 and buckle the sensor up onto the back cover to finish the installation.

#### d. Ultrasonic Sensor Configuration

DIP 123456 Address of sensor

DIP 789 Detection Distance

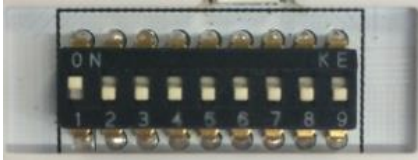

**Detection Distance:** Please refer to DIP 9/8/7 on the sensor to set up the detection distance of sensor, followed setting instruction:

**Physical Address:** To differentiate from other sensors under the same Data Collector, each sensor has a unique physical address which is setup on the **RED DIPs No.1-6** using binary system. Picture 18 in the next page is a setup guide for addresses from 0-59

6 5 4 3 2 1	Address
0 0 0 0 0 0	0
0 0 0 0 0 1	1
0 0 0 0 1 0	2
0 0 0 0 1 1	3
...	...
1 1 1 0 1 0	58
1 1 1 0 1 1	59
9 8 7	Height
0 0 0	1. 8m
0 0 1	2. 0m
0 1 0	2. 2m
0 1 1	2. 4m
1 0 0	2. 6m
1 0 1	3. 0m
1 1 0	3. 5m
1 1 1	max

#### Sensor Installation height setting

Sensor is installed directly above the parking space , As below picture shows:

1. H ( 2.1m-2.5m, best 2.2m )
2. Distance from parking space (0m-0.5m,Best 0.2m; If parking space is 6m Length, best 0m )

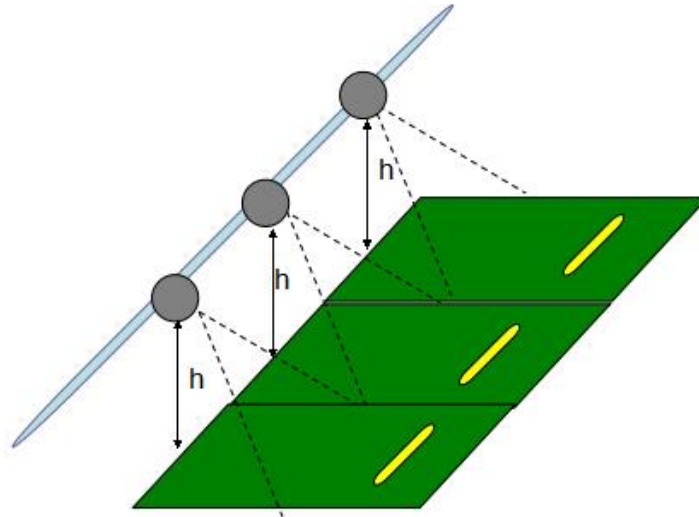

3. Beam Angle setting: According to the actual situation, adjust the probe angle, increase the recognition rate (adjustment range 25-30 degrees, Best 28 degree, If parking space length is 6m, Best 25 degree ), The midpoint horizontal line of the probe in the upper right corner is aligned with the right angle scale. As pic is 25degree 。

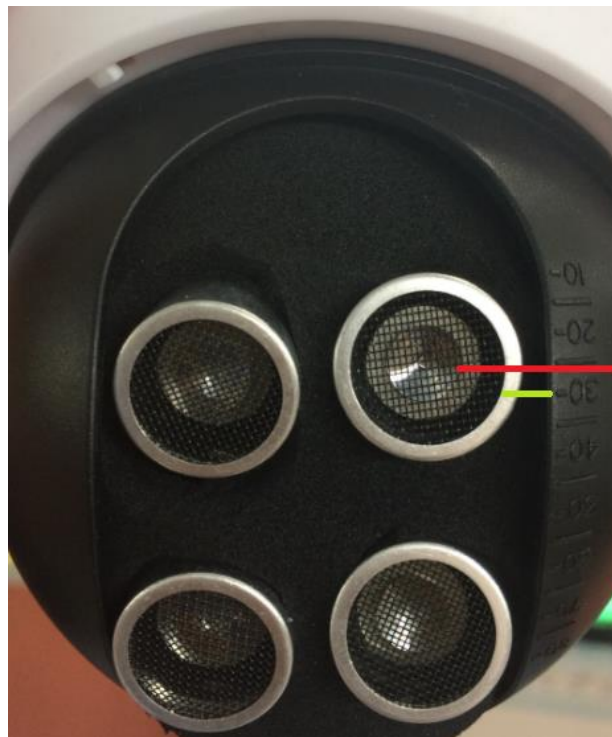

e. Install Data Collector, Centre Processor and LED Display

**Data Collector** is wall mount design; please fix it on the wall via the four preserved holes on the back of the iron housing with setscrews.

**Centre Processor** is rack mount design; please fix it on a rack with proper size screws.

---

LED Display can be wall mount or roof hang design, brackets and screws will be provided along with the housing, please install it accordingly.

## 8.2 Software Installation

Please refer to **PGS Software Installation Manual!**

# 9 System Debugging

**Attention: Before power on, please make sure the system is installed in strict accordance with our AutoCAD diagram.**

## 9.1 Data Collector

**Key points:** GREEN status lights on Data Collectors and BLUE on related sensors must be twinkling! (Communication is normal!). If the GREEN is static, there's no communication between Data Collector and sensors, and the possibilities are:

### a. Data Collector Problem

**Troubleshooting tip: test Data Collector with one normal sensor**

- a) If the GREEN on Data Collector and the BLUE on sensor are both twinkling, the Data Collector is good;
- b) If the GREEN remains static, something is wrong with the Data Collector, please replace with a new one.

### b. Ultrasonic Sensor or CAT 5 Cable Problem

**Troubleshooting tip: test the sensors & cable one by one from the nearest sensor to the farthest, see picture 1**

- a) If both GREEN and BLUE are twinkling, the sensors and cable are good;
- b) If the GREEN remains static, either the sensor or cable is broken; please check cables with tester first, if the cable is good, please replace the sensor.
- c) Repeat last step until all GREEN lights on Data Collector and BLUE on sensors are twinkling.

## 9.2 Centre Processor

---

**Key points:** On the **LCD Display** of Centre Processor, all Data Collector (been connected) status must be **OK**. (Communication is normal!)

1) If all the status is **XX**

**Troubleshooting tip: test Centre Processor with one normal Data Collector**

- a. If the status on Centre Processor LCD Display is **OK**, test the Data Collectors one by one from the nearest to farthest, see picture 2.
- b. If status on Centre Processor LCD Display remains **XX**, replace Centre Processor with a new one.

2) If only some connected Data Collector status is **XX**, there's no communication between Centre Processor and the **XX** Data Collector, and the possibilities are:

a. **Repeated Physical Address**

**Troubleshooting tip: check all Data Collector; make sure all physical addresses are sole and unique**

b. **Data Collector RG45 Problem**

**Troubleshooting tip: replace the mainboard**

c. **Cable Problem**

**Troubleshooting tip: if the problem remains after mainboard replaced, please test the cable, it probably is the cause of the problem**

Please follow above steps and make sure communication between Centre Processor and all Data Collector are normal.

## 9.3 PC Communication

**Key points:** when the PGS system is properly connected to PC via **RS485 to RS232 Converter**, and relevant **COM Port** open, the information on the **Software** must be updated at the mean time. If the info does not update, there's no communication between Centre Processor and PC, the problem can be:

1) **RS485 to RS232 Converter Problem**

**Troubleshooting tip: replace the converter and try again**

2) **COM Port Setup Problem**

**Troubleshooting tip: set up COM Port according to the software user manual**



---

## 9.4 LED Display

**Key points:** the information shown on the LED Display must be in **RED**, **GREEN** or **BLUE** color.  
(Communication is normal)

If the color is **ORANGE**, there's no communication between the LED Display and the system. The possibilities are:

1) **Wrong Physical Address**

**Troubleshooting tip: check physical address; it should be the same as in the Centre Processor configuration (Excel sheet will be provided)**

2) **LED Controller Problem**

**Troubleshooting tip: replace the LED Controller and try again**

3) **Cable Problem**

**Troubleshooting tip: replace the LED Controller and try again**

## 9.5 Configuration

**Key points:** all the information (**Number, Arrow Direction, Format etc.**) shown on **LED Display** must be in strict accordance with the customer requirements.

If any mistake, please correct them on the **Centre Processor configuration**

**Remarks: all configurations will be done in factory; if any unmentioned issues, please do not hesitate to contact the manufacturer.**

# 10 Why PGS

With PGS coordinating your parking facility, you will be able to:

- 1) Ensure a pleasurable and stress free parking experience, establish a marketable reputation for convenient and effective parking;
- 2) Ensure an eco-friendly facility by reducing toxic emissions from idling cars;
- 3) Instantly pinpoint parking spaces and ensure maximum occupancy and maximize profitability and revenues;
- 4) Back up from a supplier internationally renowned for consistent reliability.